

COLOREA CON EL PRÍNCIPE Y RAMPA

NOMBRE:

Colorea con el
Príncipe y Rampa



EL CASTILLO DEL PRÍNCIPE

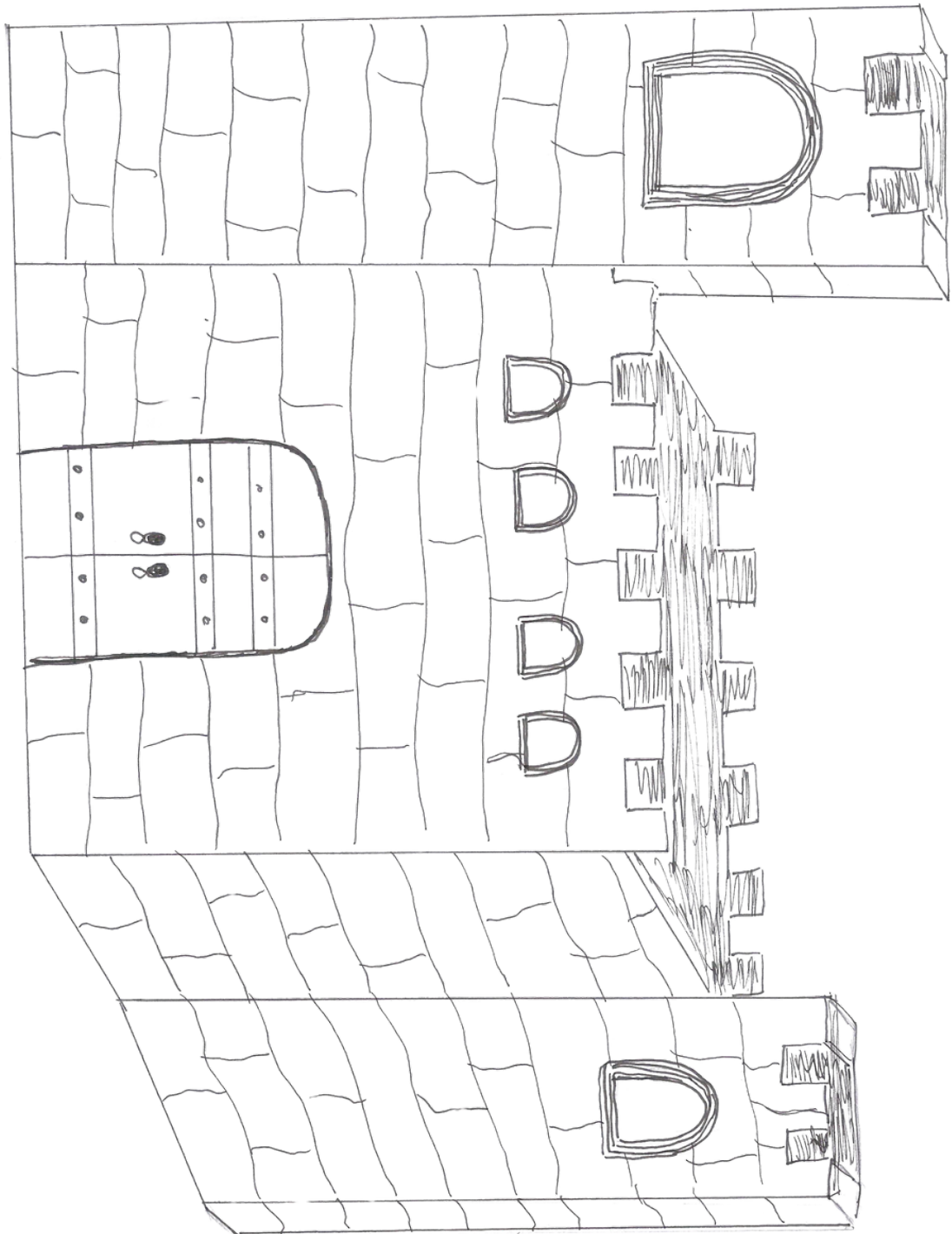

COLOREA CON EL PRÍNCIPE Y RAMPA

NOMBRE: _____

Colorea con el
Príncipe y Rampa

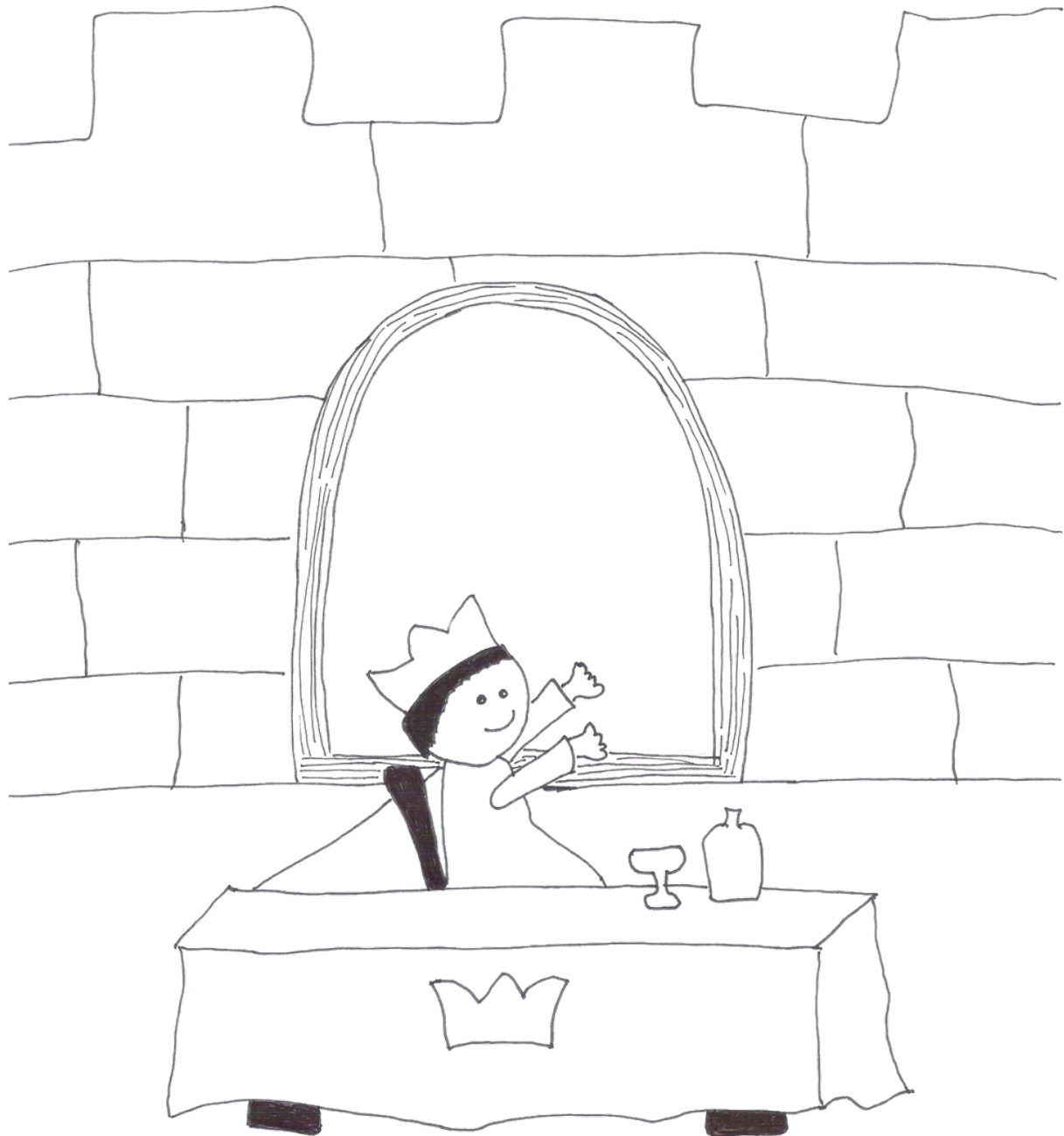

EL PRÍNCIPE EN LA TORRE MÁS ALTA

2



COLOREA CON EL PRÍNCIPE Y RAMPA

NOMBRE:

Colorea con el
Príncipe y Rampa



EL PRÍNCIPE SOBRE RUEDAS

3



COLOREA CON EL PRÍNCIPE Y RAMPA

NOMBRE:

Colorea con el
Príncipe y Rampa

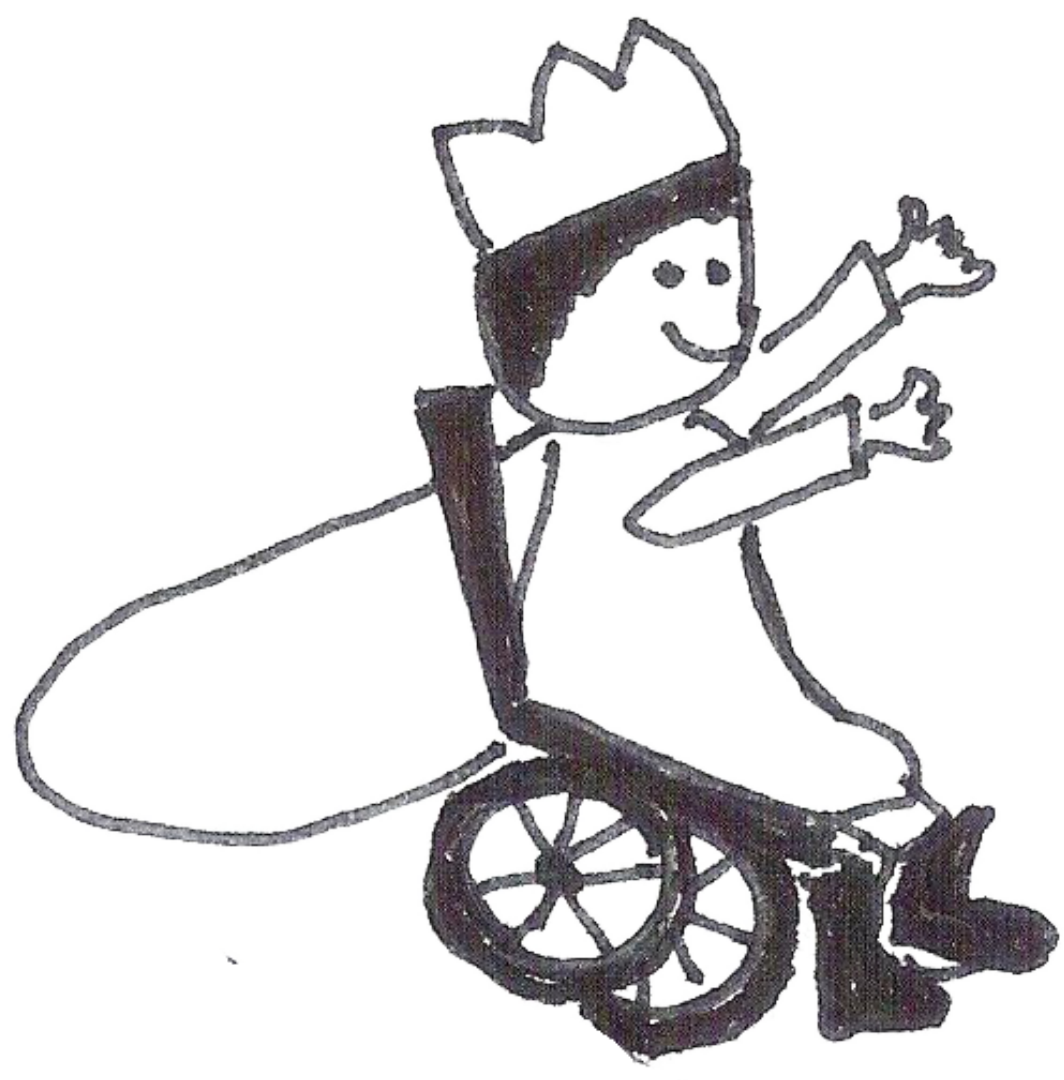

EL PRÍNCIPE SOBRE RUEDAS

4



www.cuentostolerantes.es

CUENTO: Cuenda el Príncipe Sobre Ruedas bailó
LIBRO: Cuentos tolerantes para peques y grandes



AUTORA: Ana Pujadó
ILUSTRADORA: Clara Sansinforiano Pujadó



COLOREA CON EL PRÍNCIPE Y RAMPA

NOMBRE: _____

Colorea con el
Príncipe y Rampa

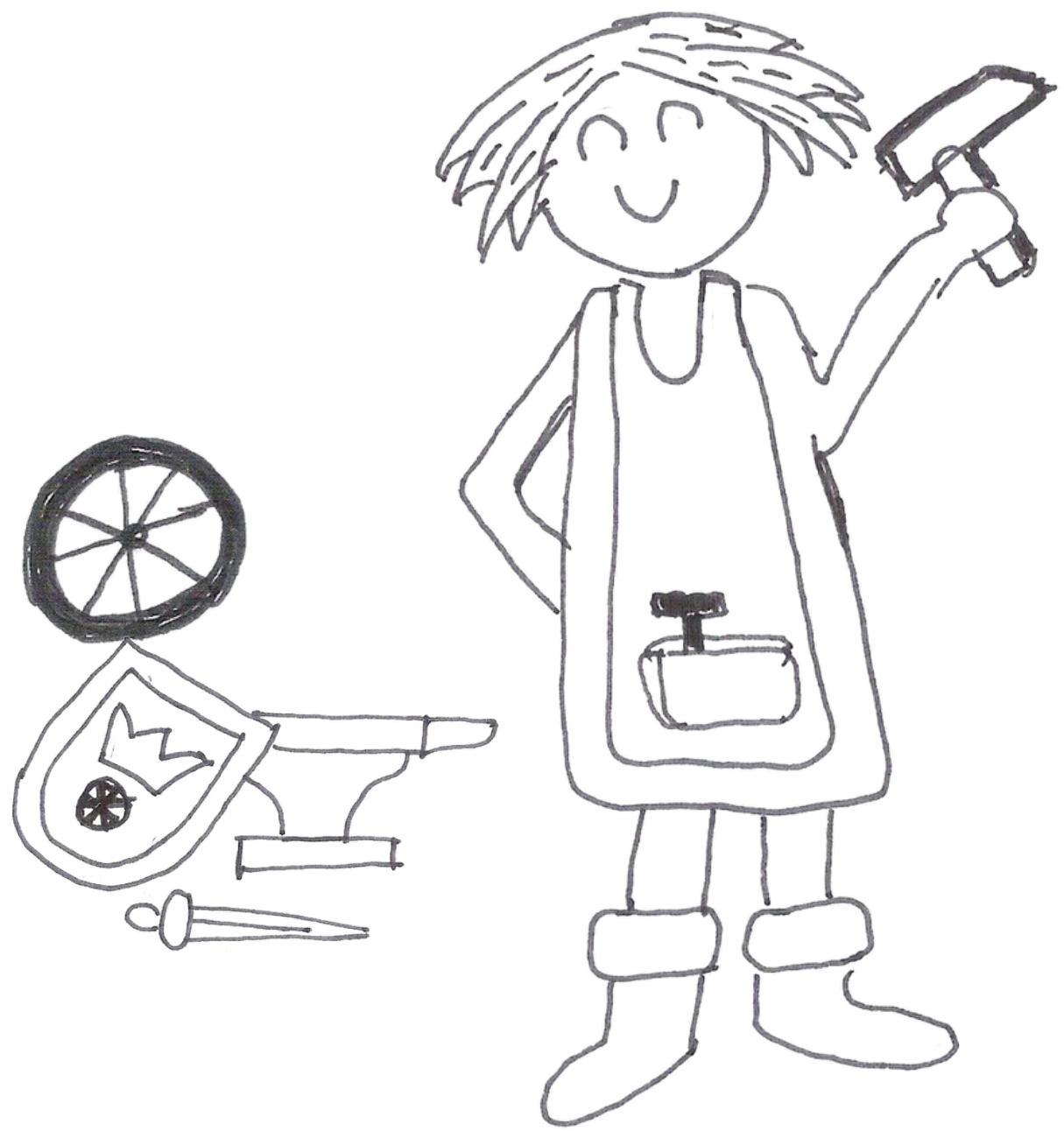

HERO, EL HIJO DEL HERRERO

5



CUENTO: Cuenda el Príncipe Sobre Ruedas bailó
LIBRO: Cuentos tolerantes para peques y grandes



AUTORA: Ana Pujadó
ILUSTRADORA: Clara Sansinforiano Pujadó



COLOREA CON EL PRÍNCIPE Y RAMPA

NOMBRE:

Colorea con el
Príncipe y Rampa



RAMPA FELIZ

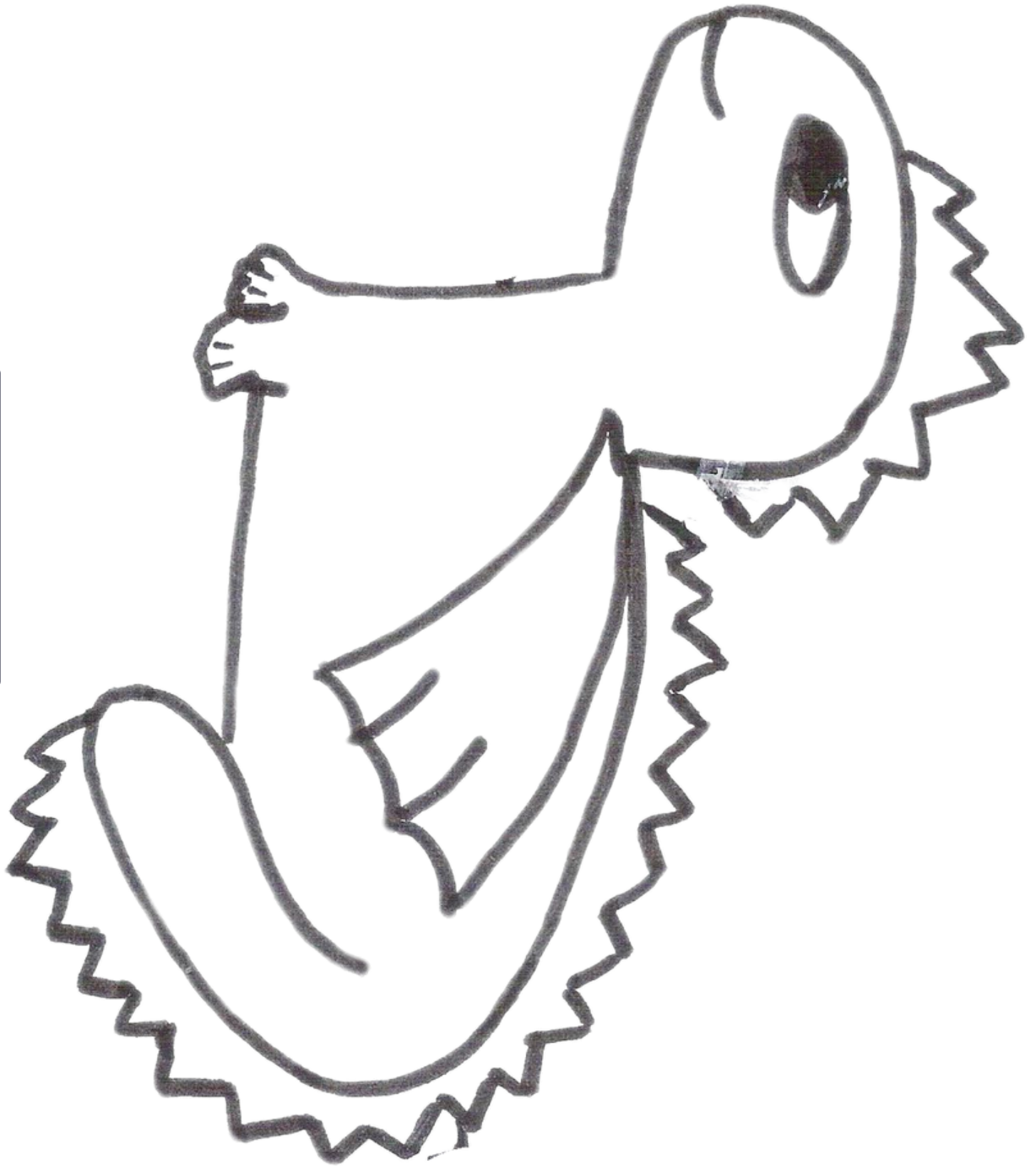

6



COLOREA CON EL PRÍNCIPE Y RAMPA

NOMBRE:

Colorea con el
Príncipe y Rampa

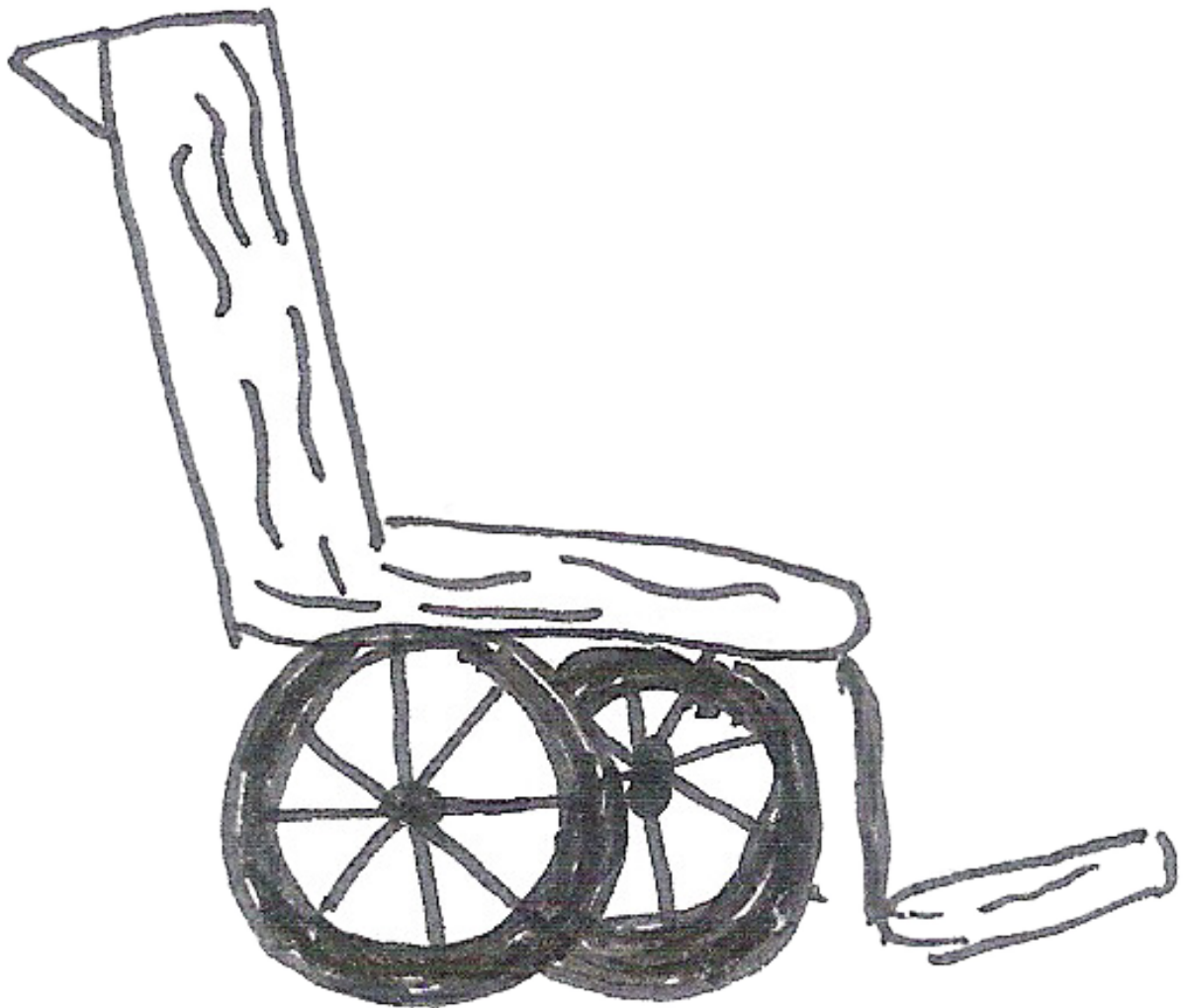

SILLA DE RUEDAS (SÚPER INVENTO)

7



COLOREA CON EL PRÍNCIPE Y RAMPA

NOMBRE: _____

Colorea con el
Príncipe y Rampa

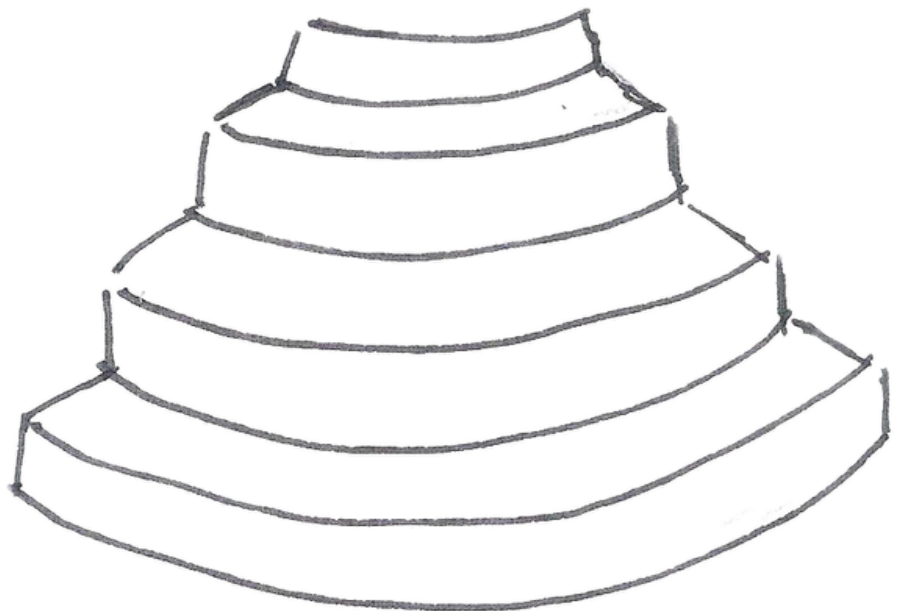
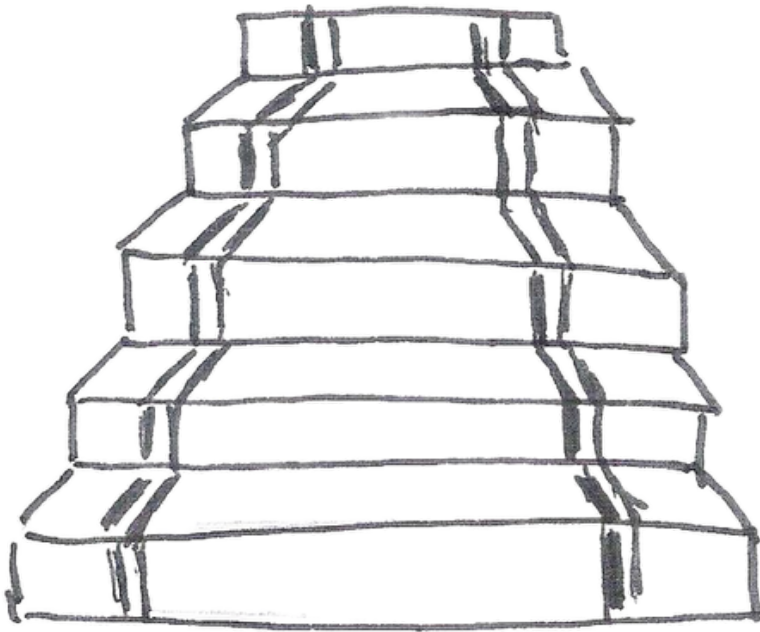

ESCALERAS QUE SON AUTÉNTICAS BARRERAS

8



COLOREA CON EL PRÍNCIPE Y RAMPA

NOMBRE:

Colorea con el
Príncipe y Rampa

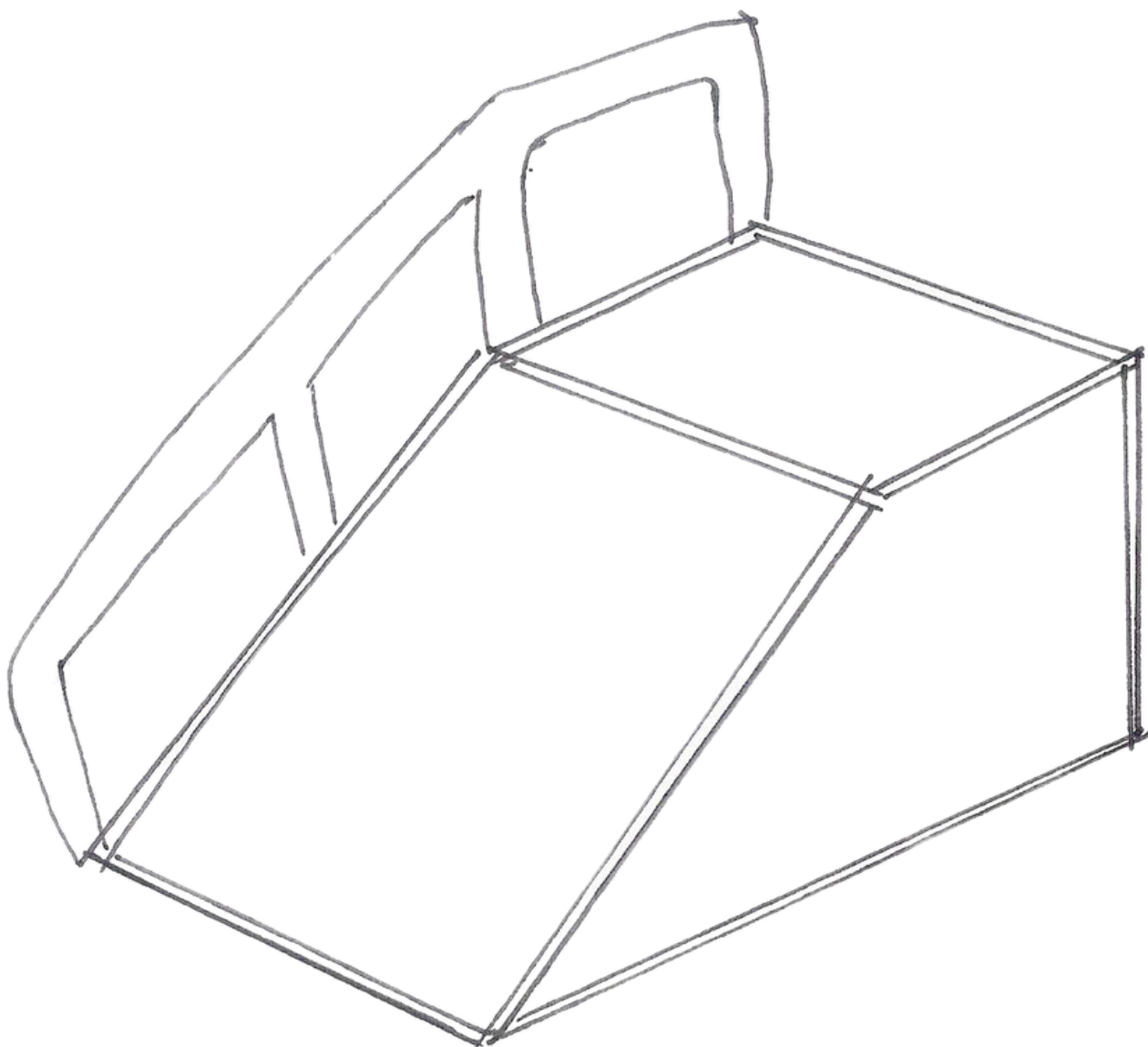

RAMPA (ROMPE BARRERAS)

9

